

NOVUM WALL™

BY REDIROCK®

BIG BLOCK
PERFORMANCE
SMALL BLOCK
CONVENIENCE

Ideal for Walls Up to 6 ft (1.8 m)



A MACHINE-SET SRW BLOCK

Weight
610 lb +/- 30 lb
(277 kg +/- 13.6 kg)



Dimensions
46 1/8 in x 20 in (plus face texture)
x 9 in (1172 mm x 508 mm [plus
face texture] x 229 mm)

Area
2.88 sq ft
(0.27 sq m)

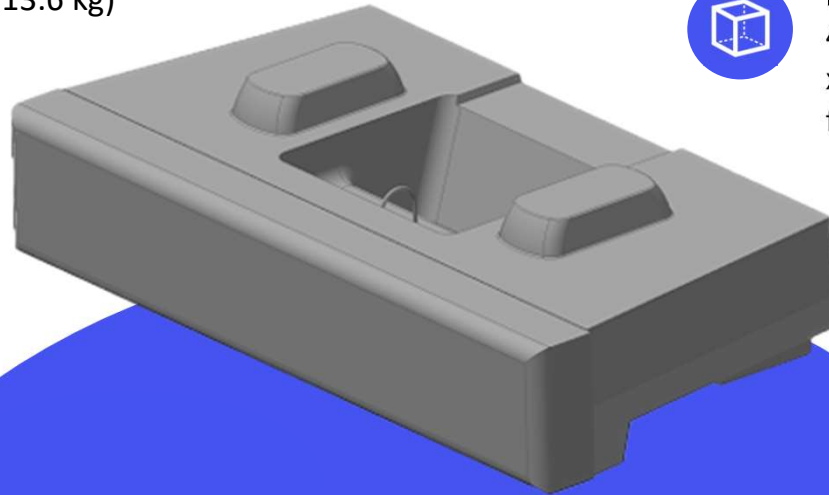

KNOBS

MULTIPLE LIFTING
HOOK OPTIONS

TRAPEZOIDAL SHAPE

FORK SLOTS

GROOVES

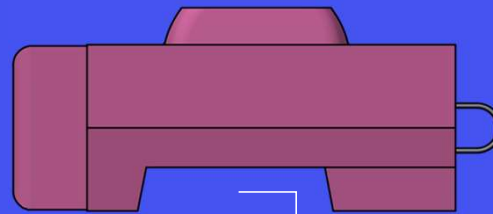
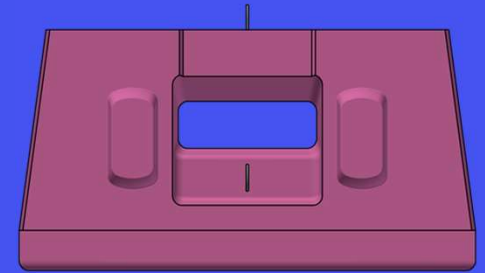
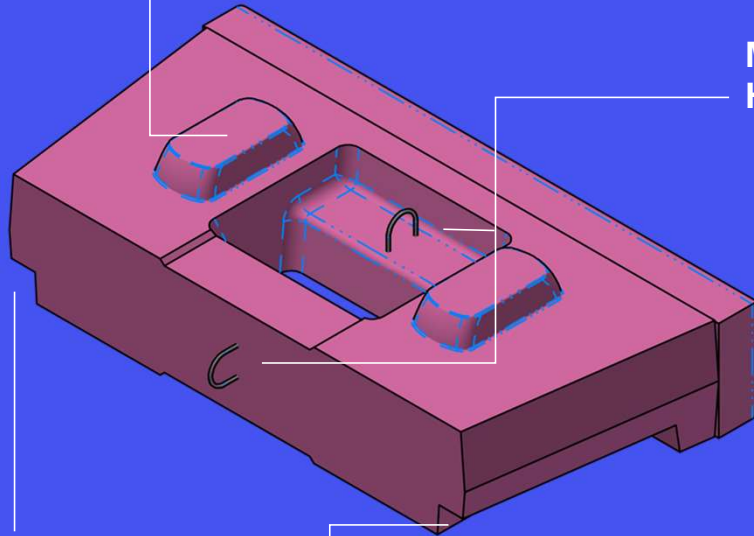

BLOCK OPTIONS

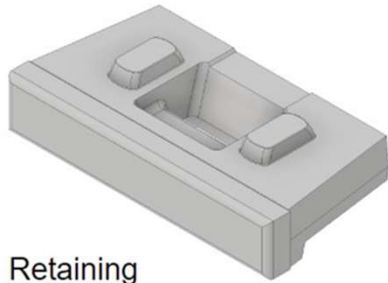

Retaining
1 Degree &
5 Degree

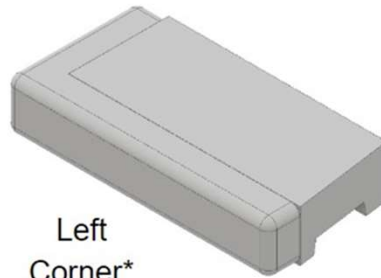

Left
Corner*

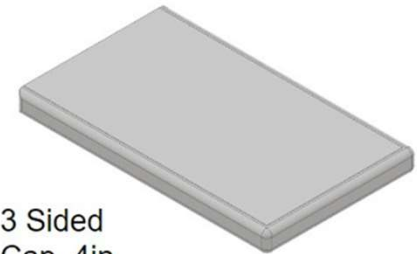

3 Sided
Cap, 4in

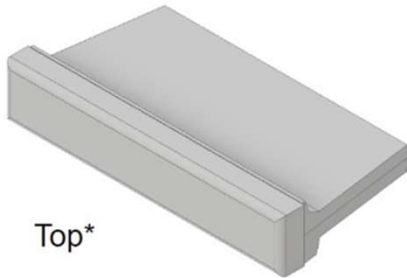

Top*

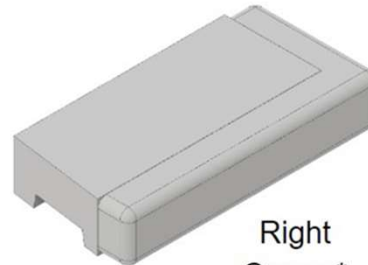

Right
Corner*

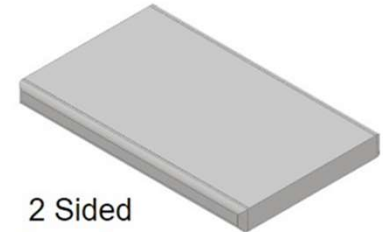

2 Sided
Cap, 4in

*Prototype shown: 2024 release



REDI-ROCK

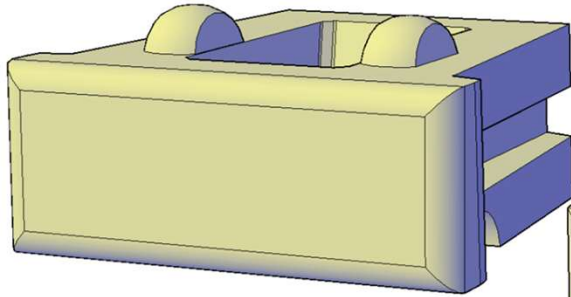

5.75 ft² (0.53 m²)

NOVUM WALL DRYCAST

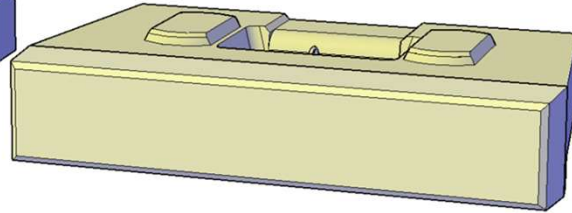

2.88 ft² (0.27 m²)

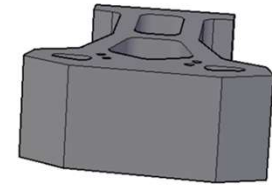

1.00 ft² (0.09 m²)



NOVUM WALL BY REDI-ROCK

FASTER MACHINE-SET INSTALLATION



NOVUM WALL BY REDI-ROCK

SMALLER MACHINERY



HIGH-QUALITY TEXTURES

*DURABLE
WETCAST*



TYPICAL GRAVITY WALL SECTION

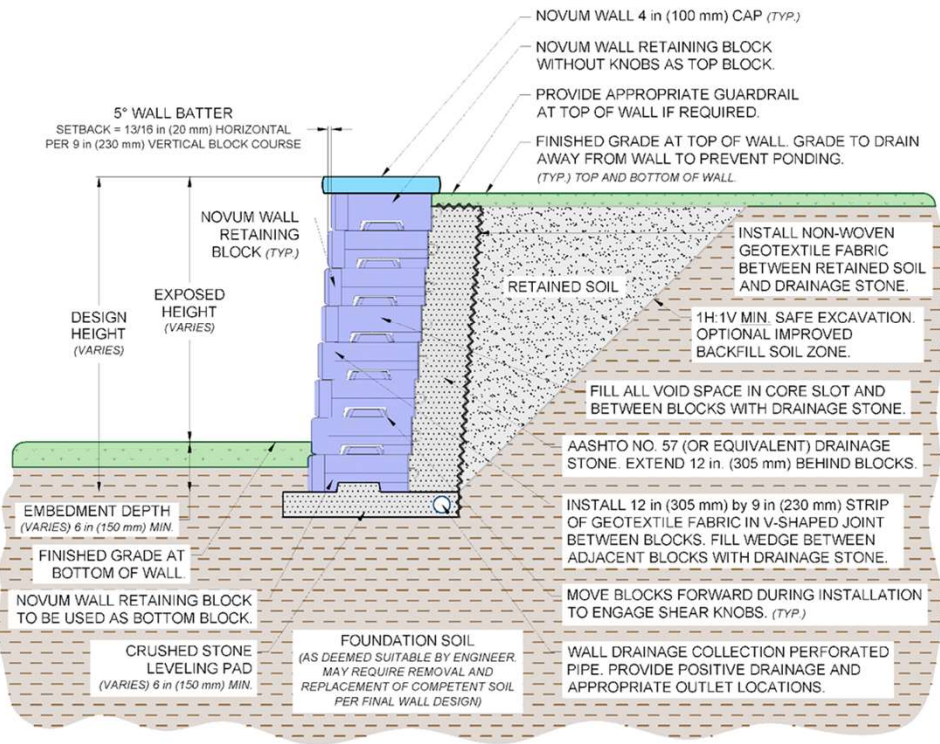

PERFORMANCE BACKED WITH ENGINEERING



GRAVITY WALLS
±6 ft (±1.8 m)

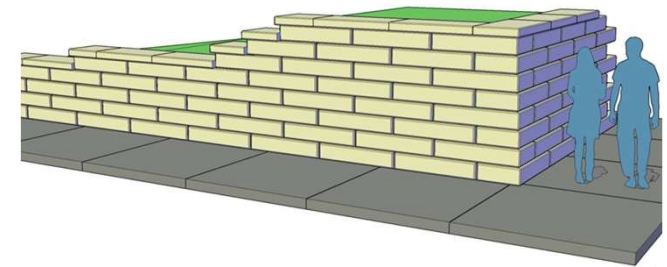

REINFORCED WALLS

±20 ft (±6.1 m)

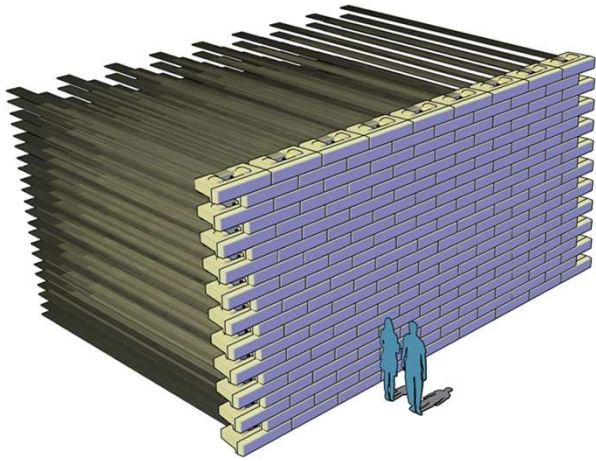

Shown: Redi-Rock Limestone Walls



RIDGE

Compatible with Redi-Rock LedgeStone

TEXTURES



SUMMIT

Compatible with Redi-Rock Kingstone

TEXTURES

